

i3LIGHTHOUSE L3502Wi

USER MANUAL



TECHNOLOGIES
www.i3-technologies.com

Index

INDEX	2
INTRODUCTION	3
OVERVIEW	3
IMPORTANT SAFETY INFORMATION	3
IMPORTANT NOTES	4
MAINTENANCE INSTRUCTIONS	4
LIMITED WARRANTY	5
i3-TECHNOLOGIES SUPPORT SERVICES	6
CONTACT i3-TECHNOLOGIES	7
PRODUCT INFORMATION	8
FEATURES	8
SPECIFICATIONS	9
INSTALLATION	10
MOUNT THE i3PROJECTOR.	10
POWER ON/OFF THE i3LIGHTHOUSE.	11
OPERATION	10
INTERACTIVE STYLUS	11
TOUCH CALIBRATION	12

Introduction

Overview

Congratulations on the purchase of your i3LIGHTHOUSE. This guide describes how to set up, use, and maintain your i3LIGHTHOUSE.

i3LIGHTHOUSE is an innovative digital learning tool for classroom environments that promotes hands-on, active learning and engages students like never before. Designed to support k-12 learning environments, the i3LIGHTHOUSE helps teachers bring lessons to life while encouraging students to play, collaborate, share and engage. Not only supports i3LIGHTHOUSE the I.Q. side of learning, but also the E.Q. side as well. Developing strong social and communication skills at an early age prepares students for a more successful learning path.

The compact and mobile design of the i3LIGHTHOUSE fits perfectly into any sized space and can be stored anywhere. The durable casters allow students and teachers to be as mobile as possible.

i3LIGHTHOUSE helps students make sense of the world around them by connecting classroom concepts to hands-on, engaging activities. Interactive tools help students develop both cognitive and social skills while having fun.

The padded cushion top gives teachers a comfortable place to sit and still interact with students without having to sit on the floor.

Important safety information

Please read and understand all safety information before using this product. Follow all instructions marked on the product and described in this, or other documents. Pay attention to all the installation warnings and safety precautions.

Intended use

The i3LIGHTHOUSE was designed as a furniture pieces, incorporated with interactive learning technology, plug and play, stand-alone unit. This product is intended for indoor use only, and is not designed for use in hazardous locations.

Definitions of safety terms

 **DANGER** indicates an imminent hazard. If you fail to avoid this hazard, it will cause serious injury or death.

 **WARNING** indicates a potential hazard. If you fail to avoid this hazard, it could cause serious injury or death.

 **CAUTION** indicates a potential hazard. If you fail to avoid this hazard, it may cause minor or moderate injury, and also alerts you about unsafe practices.

 **NOTICE** indicates information of special importance.

WARNING

To avoid the risk of electric shock which could result in serious injury or death:

- Plug the power cord into an appropriate grounded power source.
- Do not use power cord that is frayed or otherwise damaged.
- Do not place foreign objects behind the internal cover.
- Disconnect the power supply cord before removing the internal cover to reach the components.

To avoid the risk of visual problems:

- Do not look directly into the light source of the projector. This could cause permanent loss of vision.
- Caution should be taken with the intended use near persons with an epileptic condition. These persons may experience seizures when viewing certain kinds of flashing lights or patterns.

CAUTION

To avoid the risk of electric shock or fire which may result in minor or moderate injury:

- Do not use non-conforming replacements parts.
- Do not place wet objects on, or inside the cabinet.
- Do not place foreign objects behind the internal cover.
- Ensure that connecting the unit to the power source will not overload the power source.

To avoid the risk of product damage:

- Move the unit with care. This product and its components contain fragile parts. Dropping the unit may cause internal dislocation or shattering of glass parts.
- Ensure the wheel brakes are latched when operating.
- Use the product on an appropriate flat and level surface.

To avoid possible environmental contamination:

- The lamp inside this product contains mercury (Hg) and must be recycled or disposed of in accordance with local, state, or federal laws. Check your individual country requirements to see if specific recycling requirements exist for mercury containing products or other electronic products.
- Dispose of the unit according to applicable governmental regulations.

Important notes

- In extreme temperature and humidity transport situations, you may observe condensation behind the lens cover of the i3PROJECTOR. To resolve this condition, place the unit where it will be used and allow a 24-hour environmental stabilization period prior to use. Any noticeable condensation is temporary and will have no long term effect on the operation of the unit.
- Unplug the power supply cord by holding the plug. Do not pull on the cord.
- Do not connect or disconnect this product during an electrical storm.
- Install the unit in a well ventilated area. Always maintain adequate ventilation to protect the components from overheating and to ensure reliable and continued operation.
- Passive heat may cause damage to plastic materials. Do not expose to excessive sunlight or other heat sources.
- We recommend that an adult observes any young users when playing video games. If you or any user experiences any of the following symptoms: dizziness, altered vision, eye or muscle twitching, involuntary movements, loss of awareness, disorientation, or convulsions, discontinue the use immediately and consult a physician.

Maintenance instructions

- Do not install the unit in a place where ventilation may be hindered. Always allow an adequate ventilation to protect the components from overheating. The cabinet was designed with ventilation in mind, do not block these openings or vents.
- Prefer to use in low dust environments. Increase the frequency of cleaning the dust filters of the projector according to the environment.
- More specific maintenance instructions of the i3PROJECTOR can be found in its own User Manual on <http://www.i3-learning.com>.
- Keep the entire lighthouse clean and clear of gathering dust.

Limited Warranty

Thank you for purchasing an i3 product. i3-TECHNOLOGIES Holding NV values your business and always attempts to provide you the very best quality of service. Please carefully read the following terms and conditions before using the product. Your use of the product constitutes agreement with the terms and conditions of this i3-TECHNOLOGIES Limited Warranty Agreement.

A. Warranty Policy

i3-TECHNOLOGIES grants the original purchaser a standard warranty against hidden manufacturing defects for material only, subject to the conditions stated herein, for the limited warranty period which duration is specified in section B of this agreement. The original purchaser is exclusively a person who acquires the product in its original sealed package for its own use and not for commercial purposes or resale.

B. Warranty Period

Product	Standard Warranty	Extended Warranty (purchase)
i3LIGHTHOUSE	2 years	
i3PROJECTOR	3 years	
i3COMPUTER	2 years	
Projector Light Source	3 years or 10.000 hours *	5 years or 10.000 hours *

* Whichever expires first

The performance of warranty claims shall cause neither an extension nor a restart of the warranty period.

C. Warranty Claims

During the warranty period, i3-TECHNOLOGIES shall rectify faults based on material defects. The warranty claim is dealt with the replacement of defective parts or by exchanging the products for products of equal quality without invoicing labor or material costs. Ownership of replaced or exchanged parts reverts to i3-TECHNOLOGIES. Warranty claims are only accepted by i3-TECHNOLOGIES if the defective product is presented within the warranty period together with the original invoice and the original receipt from the dealer who sold the product to the first end user (specifying the date of purchase, model designation, product serial number and the dealer's name and address). Warranty claims are dealt with in consultation with the i3-TECHNOLOGIES service or other service partners authorized by i3-TECHNOLOGIES. i3-TECHNOLOGIES will always be considered not to have any knowledge about the existence of hidden defects, unless the Customer can demonstrate otherwise. The customer loses any claim against i3-TECHNOLOGIES on the basis of hidden manufacturing defects if the defect is not communicated by e-mail or registered letter to i3-TECHNOLOGIES within 8 calendar days after discovering the hidden manufacturing defect.

D. Warranty Exclusions

The warranty does not apply under the following conditions:

- Incorrect use, mechanical damage (e.g. scratches, pressure or break points), incorrect storage or cleaning, transport damage, misuse or other fault of the customer or a third party;
- Connection or use of the product for a purpose other than that for which it is intended and non-observation of the products operating and installation instructions or the valid technical and safety-relevant provisions or standards of the country in which the product is used;
- Non-observation of i3-TECHNOLOGIES care and maintenance instructions when maintaining and caring for the product;
- Operating conditions, which exceed normal office or private use (e.g. operation in smoky or dusty atmospheres or at extraordinary room temperatures and under UV/IR radiation). Separate operating conditions are specified by i3-TECHNOLOGIES for certain products if necessary;

- e. Defects or variations in the electrical power supply or circuits, the air conditioning or other ambient conditions;
- f. Force majeure, fire, flooding, chemical, or biological exposure, acts of war, acts of violence or similar events;
- g. The modification of the product by persons not authorized by i3-TECHNOLOGIES;
- h. Insufficient maintenance and repair, or the uses of non-original replacement parts and consumables not approved by i3-TECHNOLOGIES;
- i. Virus infections or use of the product with software which was not supplied with the product or which was incorrectly installed;
- j. any change in the firmware of products;
- k. Pixel errors are unavoidable in LCD and DLP technology. They only constitute a fault under the terms of this warranty if they deviate from the product specification in accordance with the data sheet (e.g. ISO 13406-2).

Accessory parts such as boxes, packaging, batteries or other consumables, which are used in conjunction, with the product and have to be replaced as expected, are not covered by the warranty. Products whose serial numbers have been modified, removed or made illegible are excluded from the warranty. Should the customer complain about faults although they are excluded from the warranty, i3-TECHNOLOGIES reserves the right to charge the customer for costs thus incurred. The warranty does not impair or influence the buyer's statutory claims against the seller due to material damage. Such claims can be asserted instead of the warranty agreed to here at the buyer's discretion. The customer will be held solely responsible for shipping damage that occurs due to the use of any packaging material other than the standard i3-TECHNOLOGIES packaging. If the customer no longer has the original packaging, proper packaging can be obtained from i3-TECHNOLOGIES.

E. Limitation of liability.

i3-TECHNOLOGIES is in no event liable for any other damage beyond the repair or replacement of the goods, unless proven physical damage to or death of natural persons, intentional or gross fault. Indirect damages are expressly excluded in any event, in any circumstance.

F. Applicable law; Place of jurisdiction

The laws of Belgium apply and Ypres is agreed upon as the place of jurisdiction for all disputes with general merchants, corporate bodies under the public law or separate assets governed by public law. The same place of jurisdiction applies if the customer has no general domestic place of jurisdiction, or moves their domicile or normal place of residence abroad following conclusion of the agreement or if their domicile or normal place of residence is not known at the time that an action is brought.

i3-TECHNOLOGIES Support Services

i3-TECHNOLOGIES provides extensive support services through our website and technical support organization. Visit the i3-TECHNOLOGIES website at <http://www.i3-learning.com>, where you can download additional instructions, software and drivers, obtain regularly updated technical documentation, and learn more about i3-TECHNOLOGIES and i3 products.

Please contact your authorized i3 dealer for Technical Support.

Whenever you contact Technical Support, please provide the following information:

- Product, model, serial number
- Detailed description of any problems
- Pictures, screenshots, or videos are often helpful.

Contact i3-TECHNOLOGIES

The contact information and details of all our offices, partners, distributors and dealers can be found on <http://i3-technologies.com/#distribution>.

Product information

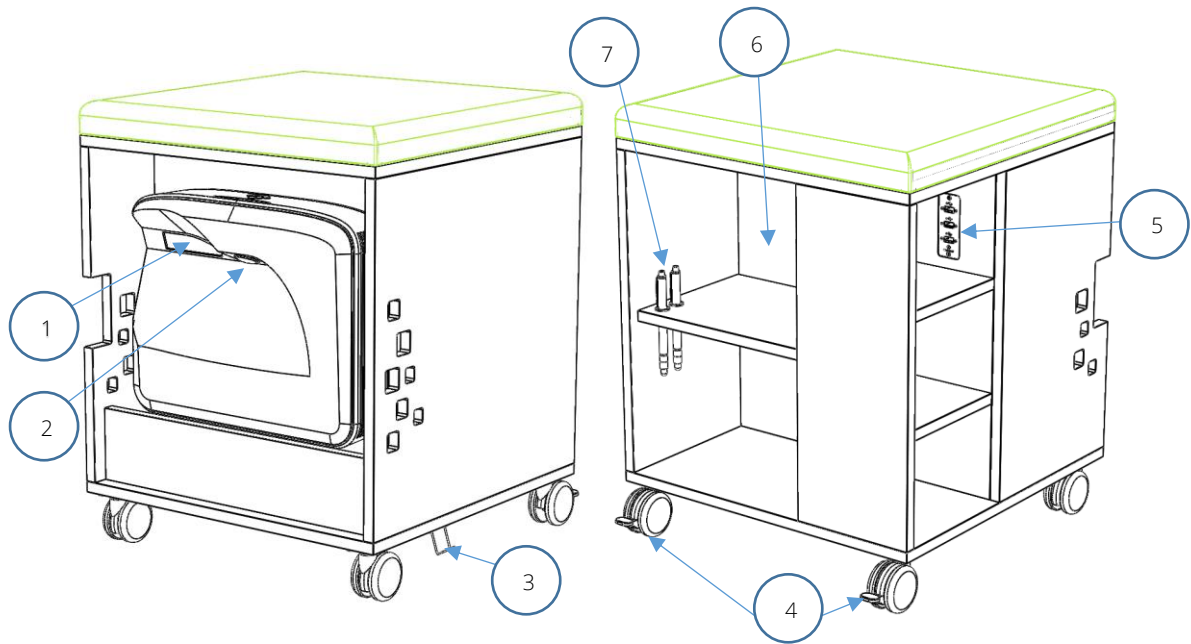

Features

Main overview

1. i3PROJECTOR lamp light source
2. i3PROJECTOR interactive camera
3. Power supply socket
4. Lockable wheels (x2)
5. USB input interface (x3)
6. Service components cover
7. Holders for interactive stylus

Components overview

8. i3PROJECTOR L3502Wi
9. i3COMPUTER 303W

Accessories overview

10. Interactive stylus (x2)
11. Remote control
12. Quick start guide
13. Microsoft Windows 8.1

Optional accessories (sold separately)

14. i3LIGHTHOUSE surface mat
15. i3LIGHTHOUSE cover

Specifications

i3COMPUTER 302W

Central Processing Unit		Intel® Core™ i3 – 4130 3M Cache, 3.40 GHz
Graphics Processing Unit		Intel® HD Graphics 4400
Memory	RAM	4GB DDR3 SO-DIMM PC1600
	HDD	500GB HDD 24/7
Networking	WLAN	Intel® Dual Band Wireless-AC 7260HMW
Operating System		Windows 8.1 Pro

i3PROJECTOR L3502Wi

Projection	LAMP	Laser Light source
	Brightness	3500 lumens
	Contrast	10000:1
	Resolution	1280 x 800
	Color	1.07 Billion colors
	Ratio	16:10
Expected Lamp Life		20.000 hours
Sound	1 Speaker	10 Watt

Installation

Mount the i3PROJECTOR.

Screw in the 2 included screws into the top 2 mounting holes. Make sure they are in identical positions.

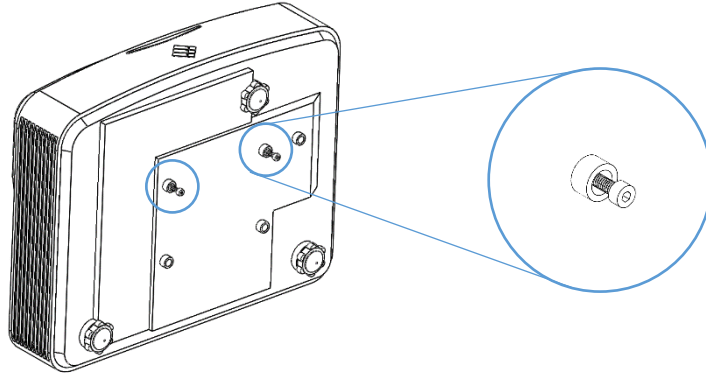

Connect the cables to the ports at the I/O interface of the projector.

- HDMI cable to HDMI1 port.
- USB cable to USB-mini port.
- Power supply cord to the AC inlet.

Mount the projector with the 2 screw in the black holding profiles of the i3LIGHTHOUSE. Make sure the projector slides all the way down in the brackets.

Connect the Power Supply Cord.

Operation

Power ON/OFF the i3LIGHTHOUSE.

The i3LIGHTHOUSE does not have a power button. It will automatically power on when the power supply cord is connected to the AC inlet of the i3LIGHTHOUSE, at the bottom of the cabinet.

To completely power off the i3LIGHTHOUSE, shut down the Windows 8.1 operating system as usual. Swipe the screen from the right side to open the Windows Charms menu. Press the Settings icon, then the Power icon, and select "Shut down".

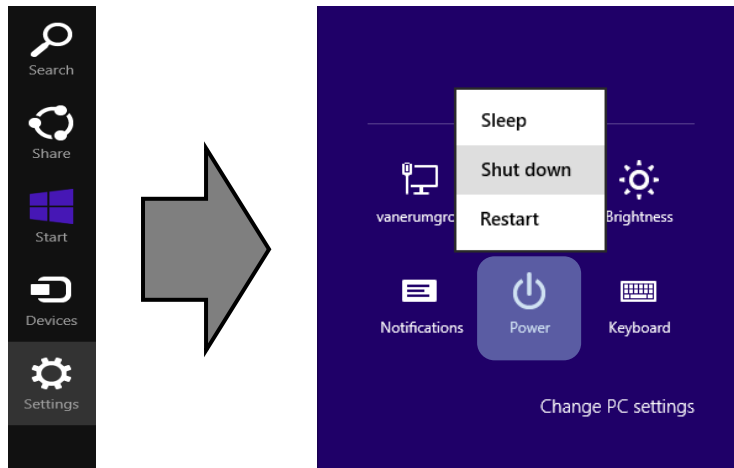

To turn on/off the i3PROJECTOR, press the POWER button on either the remote of the i3PROJECTOR, or on the projector unit itself.

Interactive Stylus

The stylus is powered on by pressing the top button. When the stylus is on, the tip of the pen should light faint orange when pressed.

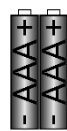

The stylus operates with 2x AAA batteries. To insert or replace the batteries, screw off the tip of the pen, and insert the batteries as indicated on the pen.

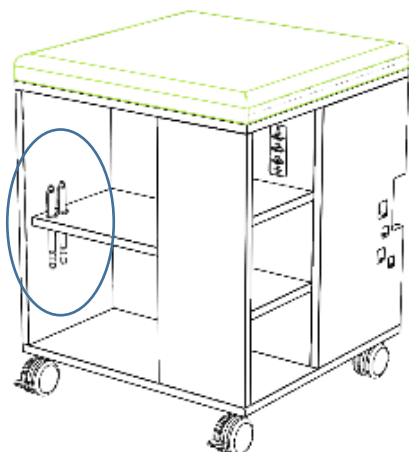
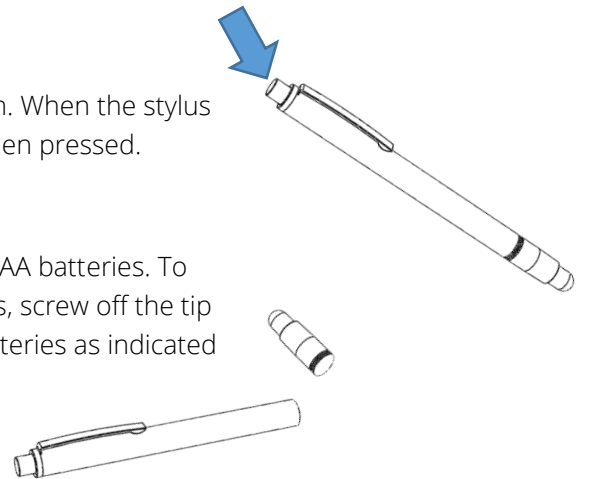

2 interactive styluses can be stored in the pen holders of the i3LIGHTHOUSE.

Touch Recognition Setup

Calibration of the touch recognition is done through the LCT program. (Check for latest version on <http://www.i3-learning.com/images/Products/i3projector/drivers/3303-windows.zip>).



LCT

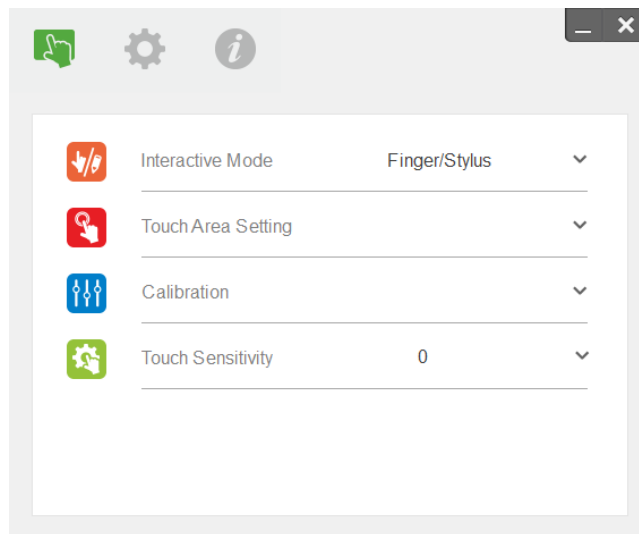

First start by correcting the **Touch Area Settings**. Either press **Automatic** or **Manual** Touch Area Setting to go through the process. Automatic Setting might not detect properly in strongly lit areas. Manual setting will generally be more precise.

After, the actual **Touch Calibration** can be performed by selecting either **Automatic** or **Manual** Calibration to go through the process. Automatic Calibration might not work in strongly lit areas. Manual Calibration will generally be more precise.

Change the **Interactive Mode** to “**Stylus**”, to improve the touch recognition.

If any touch problems appear, due to environment light, increasing the **Touch Sensitivity** can help negating light interference.

Software Setup

The **Language Setting** is located in the setting menu of the LCT program. Here you can select one of 17 languages.

The **Trouble-shooting Viewer** will detect the IR signal from the interactive pen, and display it in the viewer with a green marking. Use the Viewer to detect any interfering IR light from other sources in the environment, indicated by unidentified green markings.

The **Installation Guide** is not used for the i3LIGHTHOUSE setup. This guide is the installation process for the i3 Laser Light Curtain, not combined with i3LIGHTHOUSE.

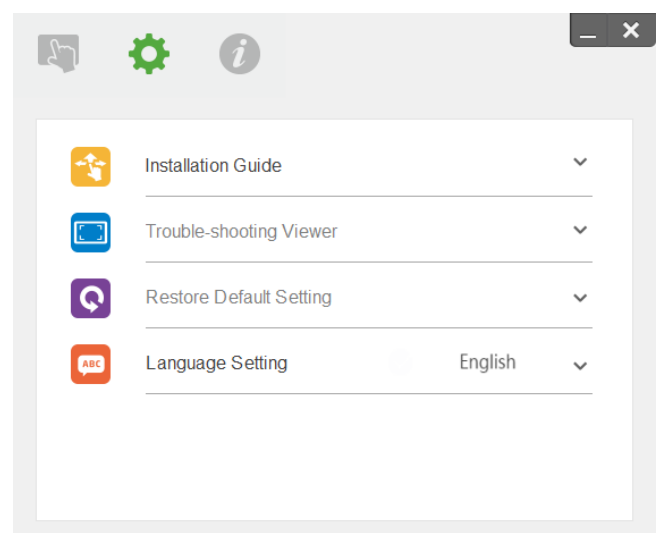

Software Information

About will display you the software version of the LCT program.

Check for updates on i3-learning.com.

Under **Help** you will find the complete User Manuals of the LCT software program.

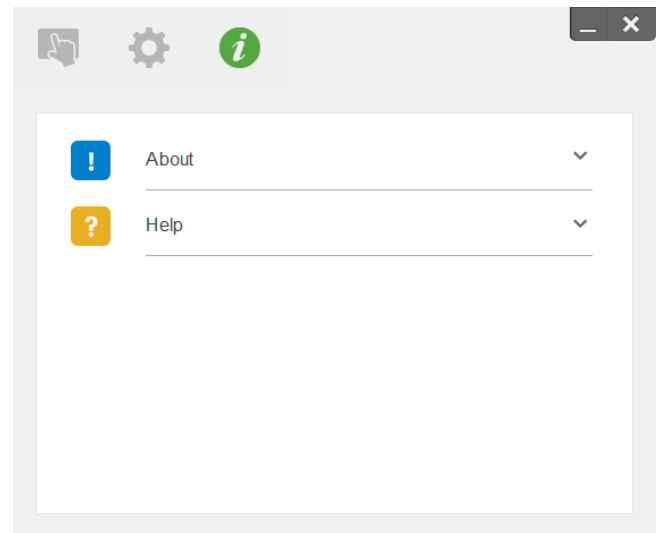

AUTHORISED DISTRIBUTOR



i3-TECHNOLOGIES

**WWW.I3-TECHNOLOGIES.COM
INFO@I3-TECHNOLOGIES.COM**