



i3-TECHNOLOGIES

MEETING



**i3 HUDDLE**  
W5502 4K C-SENSE

User Manual

# Contents

- Important Safety instructions.....3
  - 1.1 SAFETY PRECAUTION.....4
  - 1.2 MAINTENANCE.....6
- 2. Introduction .....7
- 3. Product Description .....8
  - 3.1 FRONT VIEW .....8
  - 3.2 REAR VIEW.....9
- 4. HOME Menu Description.....10
- 5. i3HUDDLE OS Setup Menu Description.....11
  - 5.1 i3HUDDLE OS Setting Overview .....11
  - 5.2 Network .....11
  - 5.3 Picture .....12
  - 5.4 Sound .....12
  - 5.5 Advanced.....12
  - 5.6 Restore .....13
  - 5.7 System Info.....13
  - 5.8 Upgrade .....13
- 6. Product Specification .....14
- 7. Product Dimensions .....16
- 8. Troubleshooting .....17
  - 8-1 Product Self-Diagnosis.....17
  - 8-2. Before Requesting Service.....17

# Important Safety instructions

[SAFETY WARNING]

- To reduce the risk of fire or electric shock, do not expose this product to rain or moisture.
- To prevent injury, this product must be securely attached to the floor/wall in accordance with the installation instructions.
  - To reduce the risk of electric shock, do not remove the back cover
  - Refer servicing to qualified service personnel if needed.

Icons used in this manual

	<b>CAUTION</b> RISK OF ELECTRIC SHOCK. DO NOT OPEN.			The lightning flash and arrowhead within the triangle indicates that there is dangerous voltage inside the product.
				The explanation point within the triangle indicates that there are important instructions accompanying the product.

[WARNING] means,

If you ignore the warning message, you may be seriously injured or there is a possibility of accident or death.

[CAUTION] means,

If you ignore the caution message, you may be slightly injured or the product may be damaged.

[NOTE] means,

The note helps you understand and use the product safely. Please read the note carefully before using the product.

When moving the product, please grab the handles behind and the bottom of the product as shown below picture.

- The product must keep horizontal and upright position when moving.
- Do not hold the corner of the product when you grab the bottom of the product.

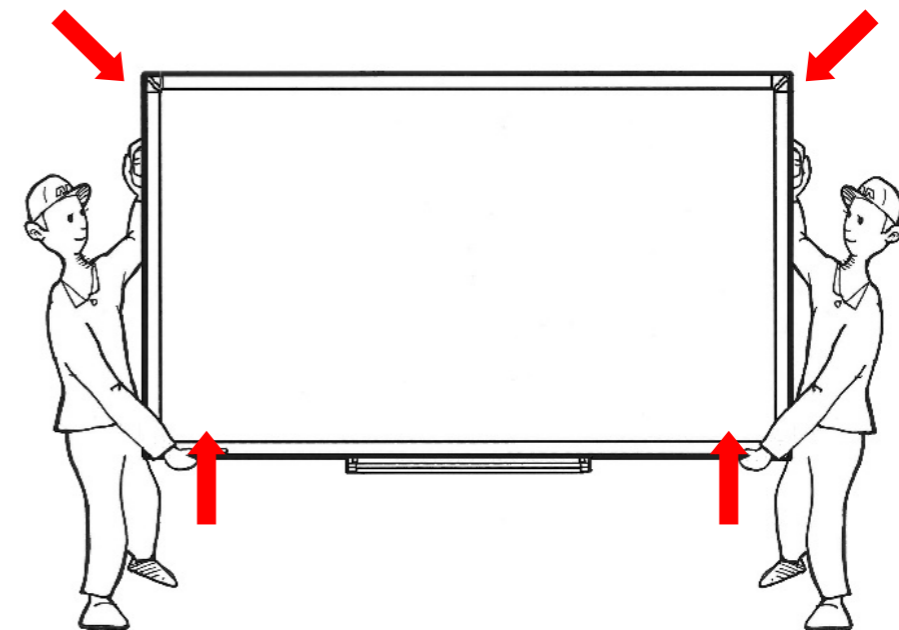

## 1.1 SAFETY PRECAUTION

Note) The color and design may differ by each model and the product specification are subject to change without notice for performance enhancement.

### 1.1.1 Power

[Warning]

- Do not use damaged power cord, plug nor loose socket. It may cause electric shock or fire.
- Do not connect multiple devices into a single s socket. It may cause fire due to overheating.
- Do not touch with wet hands when remove or plug the power cord to avoid electric shock.
- Insert the power plug into socket firmly. It may cause fire when the connections are unstable.
- Connect the power cord to a grounded wall socket. There is risk of electric shock or injury.
- Do not bend nor pull the power cord and place heavy objects over the power cord. It may occur cord damage and this may result in fire.
- Please clean only with dry cloth when the plug pin or socket are dusty. It may cause fire.

[Caution]

- Do not unplug the power plug while the product is operating. It may damage the product due to electric shock.
- Only a power cord specified by product manufacturer are recommended.

Do not use the power cord from other devices. It may cause electric shock or fire.

- Hold the plug itself when unplugging the power plug from the wall socket. If not, there is risk of electric shock or fire.
- Before moving or installing this product, be sure to turn off the power and disconnect the power cord. To turn this product off completely, you must pull the power plug out of the wall socket. Consequently, the power plug must be easily and readily accessible at all times.

### 1.1.2 Installation

[Warning]

- Do not install near any heat sources such as radiators, or other devices that produce heat. It may cause electric shock or fire.
- When mounting a product on the wall, make sure not to install the product by hanging the power and signal cables on the back of it.
- Consult with your local dealer or specialized engineer to mount the product on the wall, and use the screws and wall mounts that meet the VESA standard.

Any damages or injuries by misuse or using an improper accessory are not covered by the warranty.

- Leave a 10 cm (4 inches) (minimum) space from the wall for proper ventilation. If not, it may cause fire.
- Keep the packing anti-moisture material or vinyl packing out of the reach of children. Anti-moisture material is harmful if swallowed. If swallowed by mistake, force the patient to vomit and visit the nearest hospital. Additionally, vinyl packing can cause suffocation. Keep it out of the reach of children.
- Please note than the product must be supported on proper stands or installed according to the manufacturer's recommendations. The product that are inappropriately situated on unstable shelves, inclined planes, or vibrating places, etc., may fall over, resulting in injury.
- To reduce the risk of fire or electrical shock, do not expose this product to rain, moisture or other liquids or dust. It may cause electric shock or fire.
- Keep the product away from direct sunlight.
- Keep the product of the reach of children and install on the stable and flat place. NEVER allow children to climb on or play on the product or the furniture and stands on which the product is placed.

[Caution]

- Do not allow an impact shock or any objects to fall into the product, and do not drop anything onto the screen.
- Make sure the product is turned off, unplugged, and all cables have been removed. It may take more than 4 people to than carry.

Do not press or put stress on the front panel of the product.

- If the product is installed in a place where the operating conditions considerably, a serious quality problem may occur due to the surrounding environment. In this case, install the product only after consulting our dealer about the matter. (Places exposed to microscopic dust, chemicals, too high or low temperature, high humidity, airports or stations where the product is continuously used.)

### 1.1.3 Cleaning

[Warning]

- Before cleaning the product, unplug the power cord and wipe gently with a soft cloth to prevent scratching.
- Do not spray water or other liquids directly on the product as electric shock may occur.

[Caution]

- Do not push, rub, or hit the surface with your fingernail or a sharp object, as this may result in scratches on the screen and image distortions.
- Do not use any chemicals, such as waxes, benzene, alcohol, thinners, insecticides, air fresheners, or lubricants, as these may damage the screen's finish and cause discoloration.
- Do not spray liquid onto the surface. If water enters the product, it may result in fire, electric shock, or malfunction.

### 1.1.4 General Usage

[Warning]

- To reduce the risk of electric shock, do not open the cover or back. No user serviceable parts inside. Refer to qualified service personnel.
- Before moving or lifting the product, disconnect the power cord and all cables.
- The route cords and cables connected to the product so that they cannot be tripped over, pulled or grabbed.
- Do not stick metal objects or any other conductive material into the power cord. Do not touch the end of the power cord while it is plugged in. It may result in fire, electric shock.
- Unplug this product during lightning storms or when unused for long periods of time.
- Do not block any ventilation openings. Install in accordance with the manufacturer's instructions.
- To reduce the risk of fire or electrical shock, do not expose this product to rain, moisture or other liquids. Do not touch the product with wet hands. Do not install this product near flammable objects such as gasoline or candles, or expose to direct air conditioning.
- NEVER allow children to climb on or play on the product or the furniture on which it is placed. It may cause severe injury to children.
- Use only with a cart, stand, tripod, bracket, or table specified by the manufacturer, or sold with the product. When a cart is used, be careful when moving the cart/product combination to avoid injury from tip-over.
- Install where it cannot be pushed, pulled over or knocked down.
- It is recommended to move the product in the box or packing material that originally came in.
- When holding the product, the screen should face away from you to avoid damage.

[Caution]

- If a fixed image displays on the screen for a long period of time, it will be imprinted and become a permanent disfigurement on the screen. This is image burn or burn-in and not covered by the warranty.
- Avoid displaying a fixed image on the screen for a long period of time (2 or more hours for LCD) to prevent image burn. Recommend to power off or set the screen saver mode when not in use.
- When watching the screen, take 5 to 15 minute breaks every hour. Viewing screen for a long period of time may cause fatigue or eye strain.
- Take care not to touch the ventilation openings. When watching the screen for a long period, the ventilation openings may become hot. This does not affect the performance of the product or cause defects in the product.
- Do not install this product on a wall if it could be exposed to oil or oil mist. This may damage the product and cause it to fall.
- To install batteries in remote control, open the battery cover, replace batteries matching (+) and (-) ends to the label inside the compartment, and close the battery cover. Failure to match the correct polarities of the battery may cause the battery to burst or leak, resulting in fire, personal injury, or ambient pollution.
- To prevent to swallow the small accessories for children, keep the accessories out of the reach of children.
  - The product must keep horizontal and upright position when moving. Hold the top and bottom of the frame firmly. Handles are only for the supporting purpose.
  - When attaching the stand to the set, place the screen facing down on a cushioned table or flat surface to protect the screen from scratches by more than 2 people,
  - Make sure that the screws are fastened tightly. (If they are not fastened securely enough, it may tilt forward after being installed.)

## 1.2 MAINTENANCE

### 1.2.1 Cleaning

- When cleaning, unplug the power cord and wipe gently with a soft dry cloth to prevent scratching.
- Do not spray water or other liquids directly on the screen as electric shock may occur.
- Do not clean with chemicals such as alcohol, thinners, or benzene.

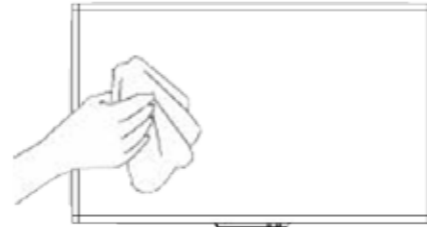

### 1.2.2 Installation

- Leave a 10 cm (4 inches) (minimum) space from the wall for proper ventilation. If not, it may cause fire or malfunction due to the high temperature product inside. [When attaching the stand] [When mounting on a wall]

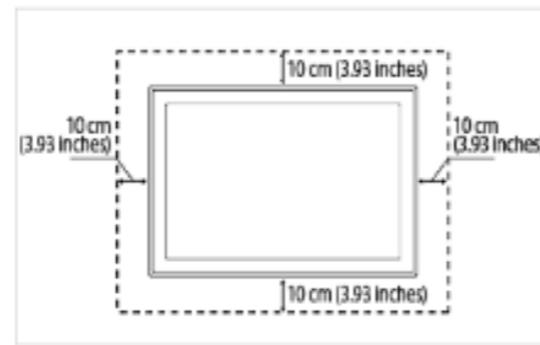
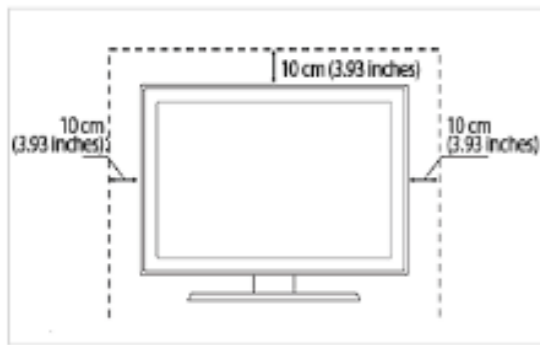

### 1.2.3 Panel

- Avoid displaying a fixed image on the screen for a long period of time (2 or more hours for LCD) to prevent image burn. Recommend to power off or set the power saving mode or screen saver when not in use.
- Due to technological constraints of the Panel manufacturer, the images generated by this product may appear either brighter or darker than normal by appr. 1ppm (parts per million) pixel.

The number of sub-pixels of a panel by size: The number of Sub-Pixels = Max. Horizontal Resolution x Max. Vertical Resolution x 3.

For example, if the maximum resolution is 1920 x 1080, the number of sub-pixels is 1920 x 1080 x 3 = 6,220,800.

## 2. Introduction

Check your product box for the following items. If there are any missing accessories, contact the local dealer where you purchased your product.

⊠ The images in this manual may differ from the actual product and item.

55" UHD PCAP Display



### Accessory

User Manual



HDMI Cable



USB Cable(for TOUCH)



Power Cable



Touch Pen x 2



Pen Holder



### 3. Product Description

#### 3.1 FRONT VIEW

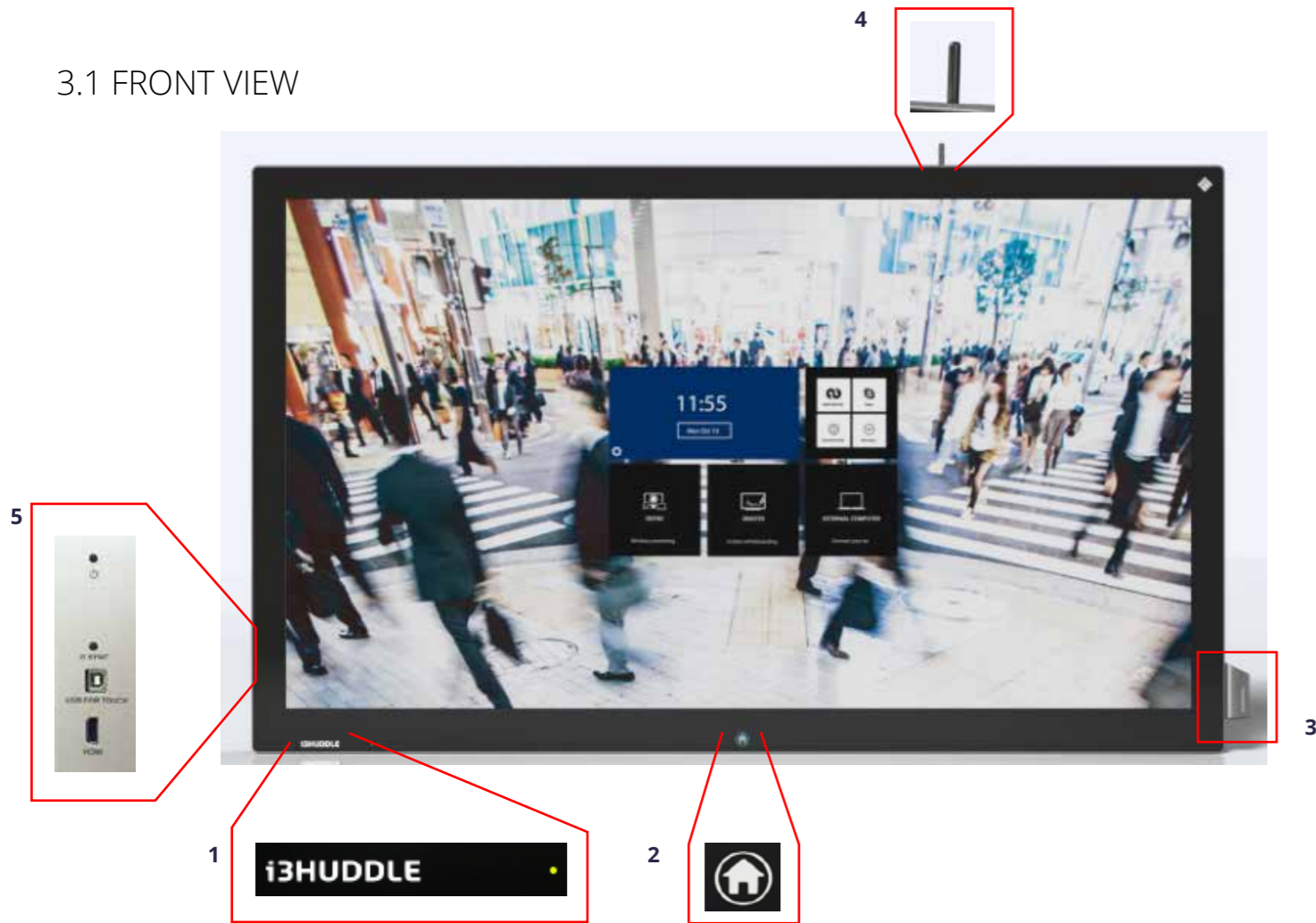

- 1** LED Indicator
  - Power ON : YELLOW
  - Power OFF: RED
- 2** Home Button (Press to go home screen)
  - Power ON : Blue
  - Power OFF : LED Off
  - \* Press the home button for 1sec to power on and 3 sec to power off.
- 3** Pen Holder
- 4** Antenna for i3 Sync (wireless screen presenting)
- 5** Side Buttons & Port
  - Power button
  - i3 Sync pairing button
  - USB B port for Touch cable connection
  - HDMI port for external source

#### 3.2 REAR VIEW

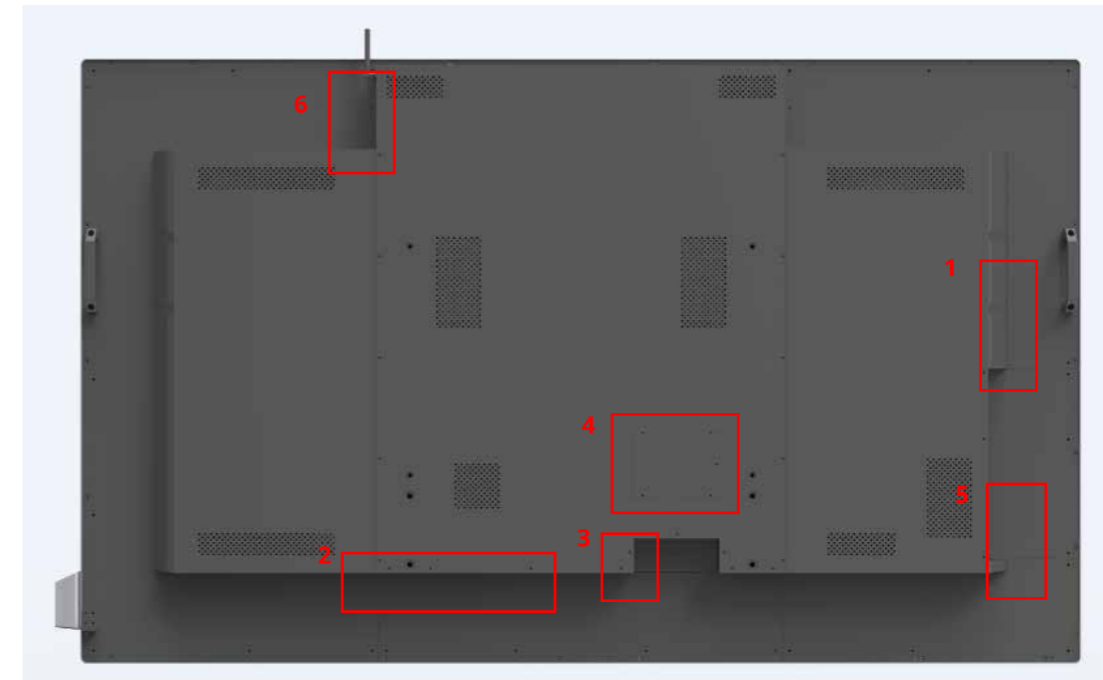

**1**

- Power: ON / OFF
- Menu: Display the main screen menu
- Source : VGA, HDMI1, HDMI 2, EXT. COMPUTER
- Vol +: Volume Up (Right)
- Vol -: Volume Down (Left)
- Move Up
- Move Down

**3**

WAN(Wide Area Networks) Ports  
LAN(Local Area Networks) Ports

**2**

1 2 3

1) AC IN : 100V~ 240V, 50/60Hz  
2) RS-232C  
3) Audio Line out

- 4** Bracket for F/W update
- 5** OPS Slot
 

When you need to install OPS PC, there is a slot on Ø for OPS PC. When you need to install OPS, remove screws and existing cover first and screw up again after mounting OPS PC in the slot.

  - Note that when using OPS PC Connection
  - Do not connect touch sensor USB cable to the port.

(Touch sensor cable is already connected by internal OPS docking board.)

  - Power on LED Display, OPS turns on automatically.
  - Power off LED Display, OPS turns off automatically.
- 6** USB port for Web Camera

## 4. HOME Menu Description

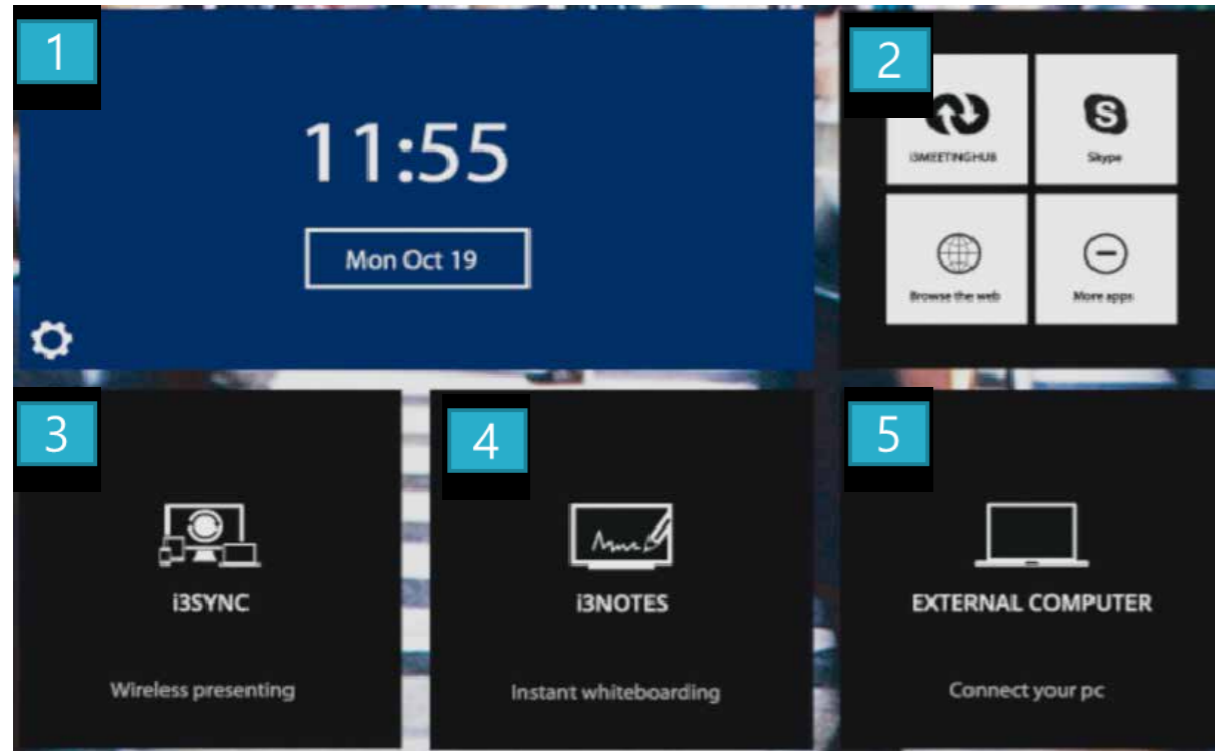

### 4.1 Menu Overview

In this home menu screen, there are several buttons to change the sources or functions easily. If you press the Home button on the bezel, this home screen always will appear.

#### 1) Time & Date, i3HUDDLE OS setting

- To indicate time & date
- Select button  to set up the i3HUDDLE system. (for more details as follows next page)

#### 2) To go OPS

Select the button to move OPS and enable to connect i3 Meeting Hub, Skype, Web Browsing, and the other applications in Windows.

#### 3) To go i3SYNC

Select the button to move the screen to connect wireless presenting solution.

#### 4) To go i3NOTES

Select the button to use the i3NOTES, writing application equipped on i3 Huddle.

#### 5) Go to External Computer

Select to button to connect external PC or devices connected by HDMI cables.

## 5. i3HUDDLE OS Setup Menu Description

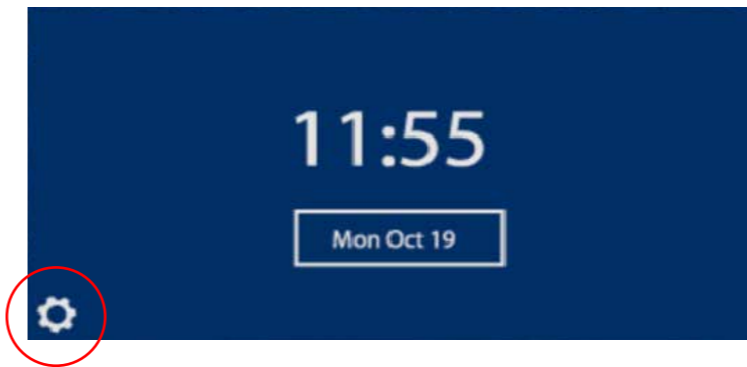

※ Select the  button for i3HUDDLE OS setup then you can see the below menu screen

### 5.1 i3HUDDLE OS SETTING OVERVIEW

- Network : to setup the Ethernet
- Picture : to setup the brightness, color, and contrast
- Sound : to setup the sound features
- All app : to go application
- Advanced : to setup Power option and background image
- Restore : to reset the system
- System info : to check the system information
- Upgrade : to upgrade system F/W

### 5.2 NETWORK

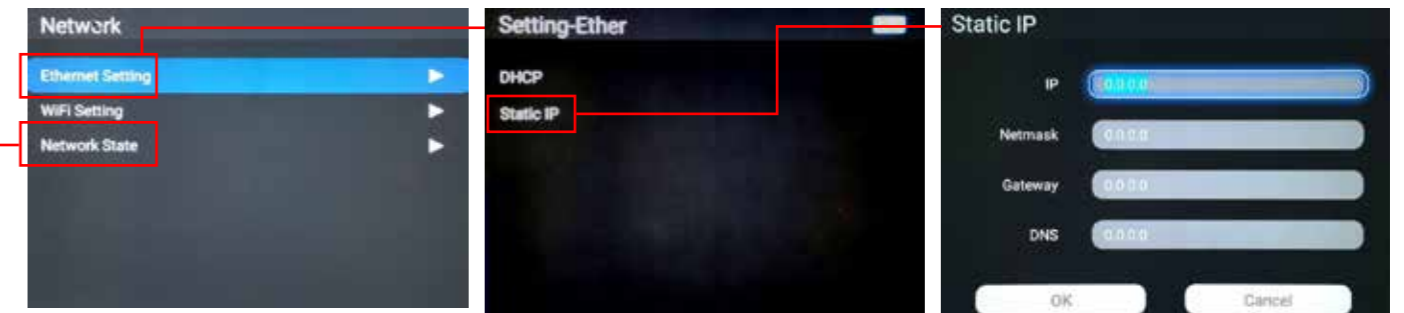

**Ethernet Setting**  
To set up the IP automatically by DHCP (Dynamic Host Configuration Protocol) or input the IP address manually in Static IP setting

**DHCP (Dynamic Host Configuration Protocol)**  
To set up the IP automatically, select DHCP then "Getting IP" messages shows up and it automatically assigned the IP address. This IP is dynamically assigned so it subject to change.

**Static IP**  
To set up IP address manually by inputting fixed IP. (IP, Netmask, Gateway, DNS)

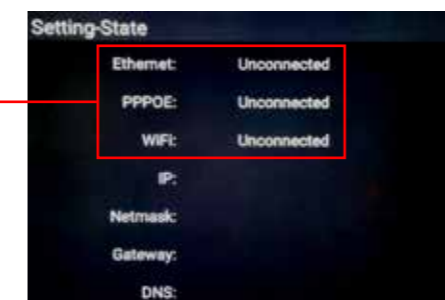

**Network State**  
To check the current network status of this system. Ethernet, PPOE, WiFi  
If it is not connected any network, shows "Unconnected" and shows "Connected" when it connected to network. Also, IP, Netmark, Gateway, DNS information turns on when connected.

### 5.3 PICTURE

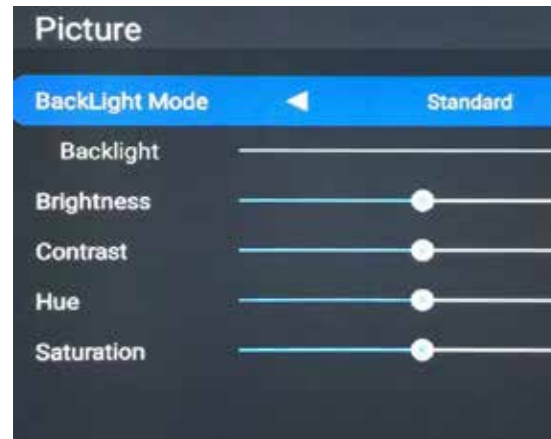

- Backlight Mode : User can set the Backlight Mode .There are Standard, Energy save, Auto, and Custom Mode. Users can adjust each value in Custom Mode.
  - Backlight : (less) 0 to 100 (more) of the Backlight
  - Brightness : (less) 0 to 100 (more)of the screen bright
  - Contrast : (less) 0 to 100 (more) of the color
  - Hue : (less) 0 to 100 (more)of the color
  - Saturation : (less) 0 to 100 (more)of the color

### 5.4 SOUND



- Sound Mode : User can set the Sound Mode .There are Movie, Meeting, Classroom, Custom Mode. Users can adjust each value in Custom Mode.
  - Bass : (less) 0 to 100 (more) of bass sound
  - Treble : (less) 0 to 100 (more) of treble sound
  - Balance : (left) 0 to 100 (right) of the speaker volume balance
  - volume : (less) 0 to 100 (more) of the volume

### 5.5 ADVANCED



- Advanced : to setup the advanced function.
  - Language : User can set the OSD menu language.
  - Input Method : User can set Keyboard type (AOSP and IME Type)
  - Sleep Off : User can set time to shut down automatically after setting time.
    - (Off, 15, 30, 45, 60, 90, 120, 240 minutes)
  - Touch Tone : User can set the touch sound (on/off)
  - Power Music : User can set the sound when power on. The Music list up when this on
  - Music No.: User can set the type of music (Music 1, Music 2)
  - Boot Channel : User can set the start screen when the system power on.
    - (, Force Input Source, Remember Input Source)
  - Source : when select the Force Input Source, user can change the Source
    - (HDMI, DP, OPS)
  - Boot OPS : User can set up the OPS on/off option when power on.
  - System Time : To set up System time and date, time zone, etc.
  - Wallpaper : To set the wallpaper of the Home screen.
  - Set ID : For RS232 communication, set from 0 to 99.

### 5.6 RESTORE

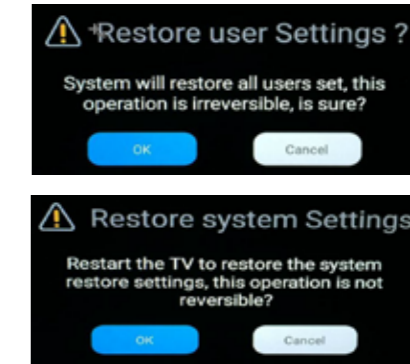
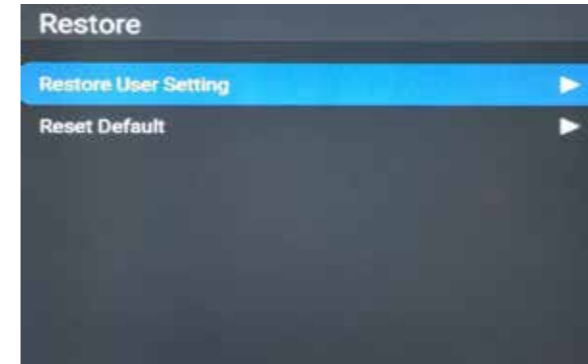

- Restore : To reset the system
  - Restore user Setting: to reset to user setting
  - Restore Default : to reset factory setting

### 5.7 SYSTEM INFO



- System Info : To check the system information
  - (CPU, GPU, Memory, OS version)

### 5.8 UPGRADE



- Local Update
  - To upgrade F/W, connect the USB on the back side "Bracket for F/W update" and then select Local Update and D drive.

## 6. Product Specification

Note: Product design and features without prior notice may be changed.

### System Specifications

Items	Specifications
Detection method	Projected Capacitive Touch sensor
Touch tool / Touch points	Hand or capacitive pen / 10 Points
Supported OS	Window 7, 8, 10
Resolution(Pixel)	3,840 x 2,160 (UHD)
Front Glass	Tempered Glass 4.0t (Anti-glare Type)
Overall dimensions(WxHxD)	1,302 x 786 x 83mm
VESA Mount	400(H) x 400(V) (mm), M8 Screw
(Net) Weight	49 kg

### LED Panel Specifications

Items	Specifications
Active screen size (Diagonal)	55"/138,8 (cm)
Display Colors	10bit, 1.06Billion colors
Brightness	500 cd/m <sup>2</sup>
Contrast Ratio	1100:1 (Typ.)
Display frame rate	60 Hz
Response Time	8.0ms (Typ G to G)
Aspect Ratio	16:9
View Angle(Typ.)	H: 178° / V: 178° (CR>/=10)

### Ratings of Environment

Item / Model	Specifications
Storage Temperature	- 20 ~ 60 °C (-4 ~ 140 °F)
Operating Temperature	0°C ~ +35°C / 20~98%RH (no condensation)
Power Supply Voltage	100 - 240V AC, 50/60 Hz
Power Consumption	Max. 130W (Standby <0,5W)

### Input/output Description

Items	Features	
System Parameter	CPU	Quad-Core, 64 bit Cortex-A53
	GPU	Hexa-core ARM Mali-450 , Dual-core VPU
	CPU Clock Speed	1.2GHz
	Flash	8GB Build in Emmc
	SDRAM	2GB(2Gbit X 4) ; DDR3 ; 1866MHz
	i3HUDDLE OS	Version 5.1.1
	Kernel	3. 1. 10
	HDMI	Input Signal
Color		225MHz@1080p 60Hz 12bit deep-color
Terminals	R232	RS232 jack X 1
	WAN	WAN RJ45 X 2 (10M/100M Adaptive)
	Other Audio In	Line Out
AMP Output	10W X 10W (8 Ω)	



## 7. Product Dimensions

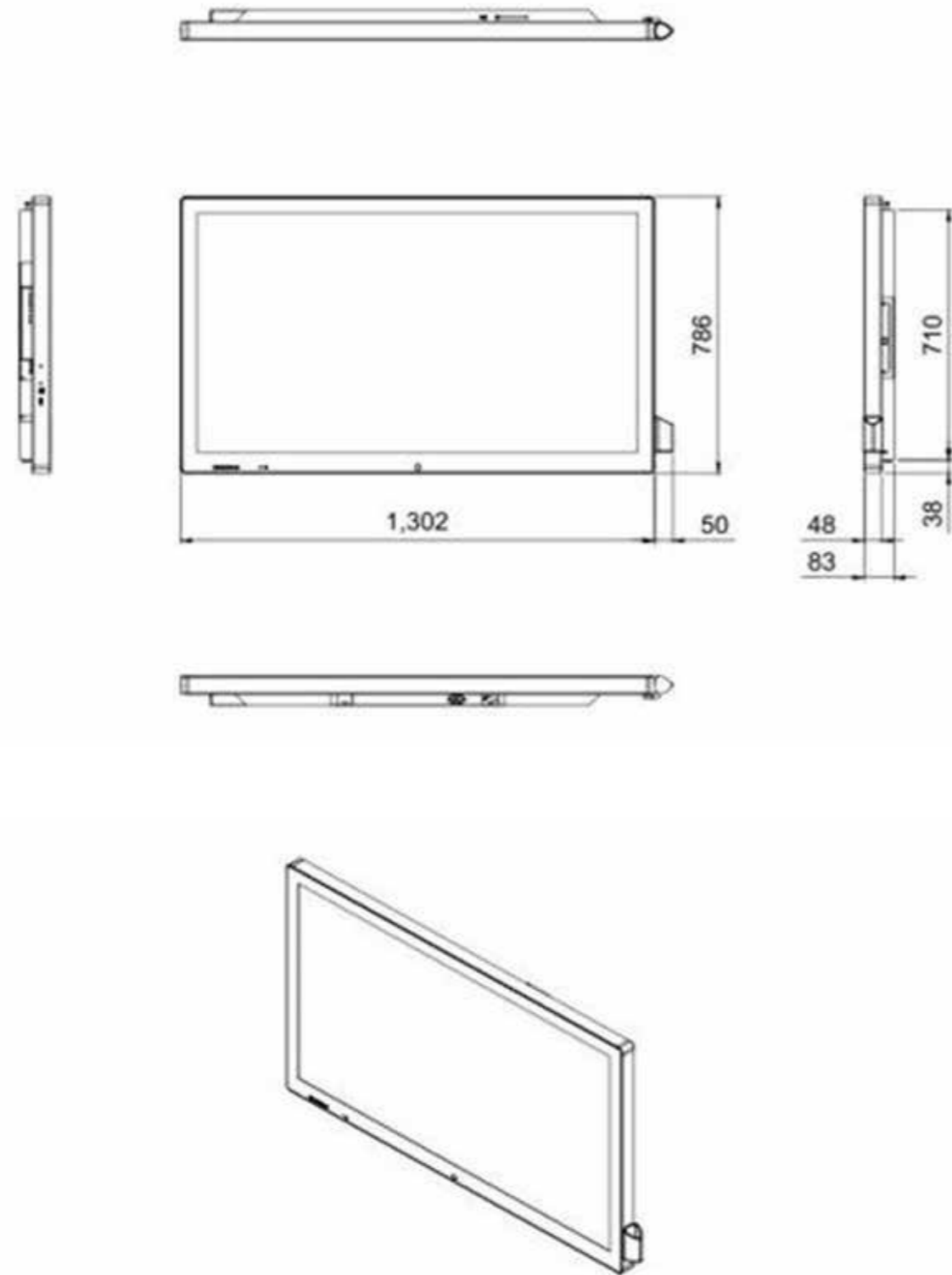

## 8. Troubleshooting

### 8-1 PRODUCT SELF-DIAGNOSIS

- You can check if the product is working properly using the Self-Diagnosis function.
- If a blank screen is displayed but the Power LED on even if the product and the PC are properly connected, perform the self-diagnosis function according to the procedures below.
  - Turn the product and the PC off.
  - Remove the any connected cables from the product.
  - Turn the product on.
  - If the product is working properly, the <No Signal>message appears.

In this case, if a blank screen is displayed again, make sure that there is no problem with the PC and the connection.

### 8-2. BEFORE REQUESTING SERVICE

- Please check the following before requesting After-Sales service and if the problem continues, please contact the local dealer where you purchased your product.

#### 1) PROBLEMS RELATED TO SCREEN

A. Screen is blank and power indicator is off.

» Ensure that the power cord is firmly connected and the monitor is on.

B. "No Signal" Message.

» Check the maximum resolution and the frequency of the video adapter.

» Compare these values with the data in the Standard Signal Mode Table.

C. Images looks like flows down the screen.

» Check if the signal cable is securely connected. Connect it again securely.

D. Image is not clear. Picture is blurred.

» Run frequency tuning.

» Turn on again after removing all accessories. (Video extension cable, etc.)

» Set resolution and frequency to the recommended ranges.

E. The image is too light or too dark.

» Adjust the <Brightness>and<Contrast>and<Backlight>.

#### 2) PROBLEMS RELATED TO AUDIO

A. No sound.

» Ensure that the audio cable is firmly connected to both the audio-in port on your monitor and the audio-out port on your sound card.

B. The sound level is too low.

» Check the volume level. If the volume is still too low after turning the control to its maximum, check the volume control on the computer sound card or software program.

